

HANDLEIDING



Container ombouw Peter



BENODIGDHEDEN

Benodigde gereedschappen

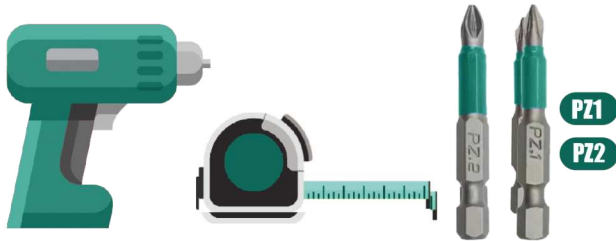

Plank 135 x 16 mm

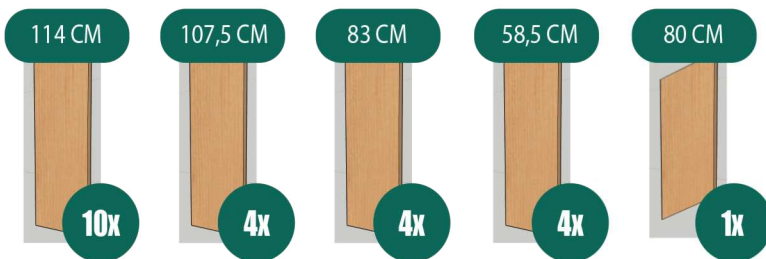

Balk 67 x 44 mm



Balk 44 x 44 mm

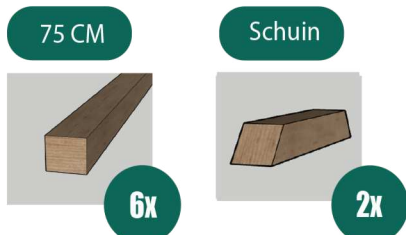

Instructies

Controleer alle onderdelen op deze onderdelen lijst vóór montage. Start niet met monteren bij ontbrekende onderdelen.

Neem de instructies van montage aandachtig door en volg deze stap voor stap voor een goede montage.

Voor optimale bescherming van de materialen adviseren wij het product op een vlakke en verharde ondergrond te plaatsen.

Losse onderdelen

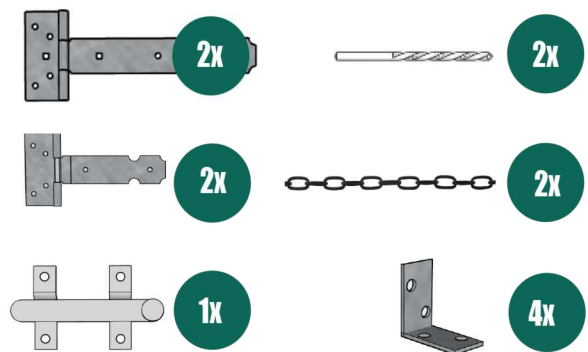

Schroeven & pluggen



! Let op: Alles voorbereiden

MONTAGE STAPPENPLAN

Montage stap 1

- 2x Balk 67x44mm van 119 cm
- 1x Balk 44x44mm van 75 cm
- 4x Schroef 80 mm

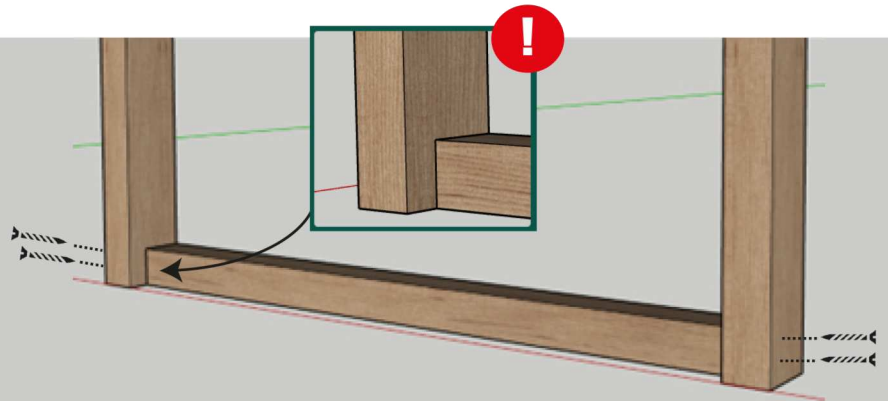

Montage stap 2

- 1x Balk 67x44mm van 75cm
- 4x Schroef 80mm

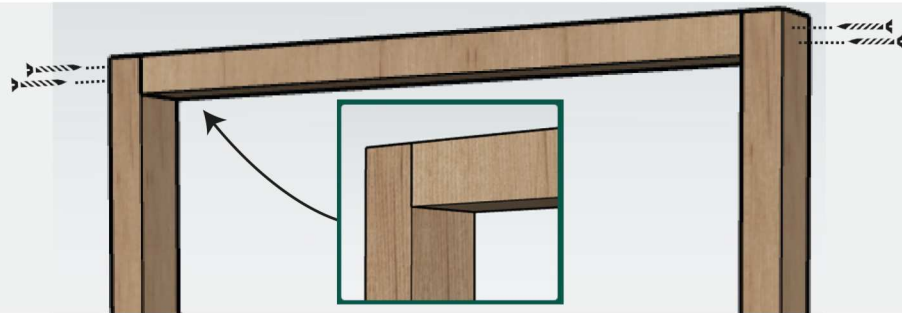

Montage stap 3

- 1x Balk 44x44mm van 75cm
- 3x Schroef 80mm

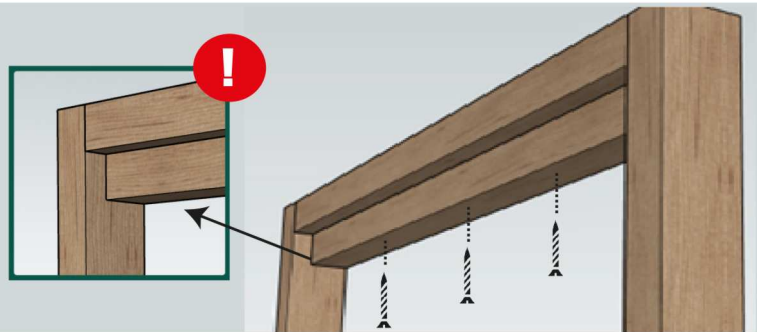

Montage stap 4

- 1x Balk 44x44mm van 75cm
- 4x Schroef 80mm

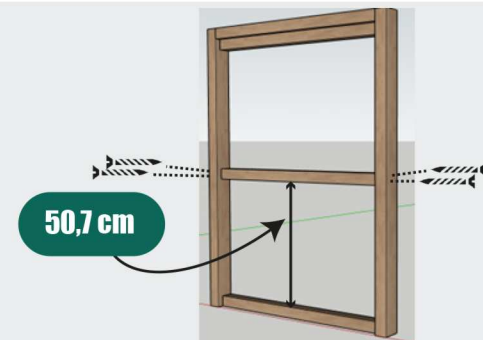

Montage stap 5

- 5x Plank 135x16mm van 114cm
- 30x Schroef 30mm

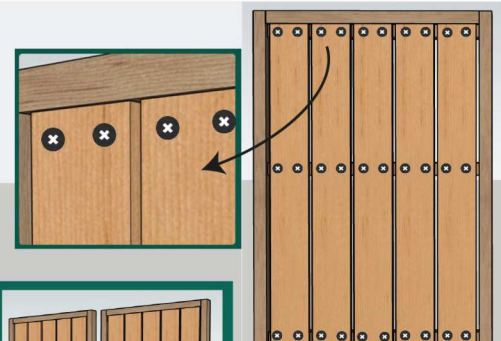

Montage stap 6

Herhaal stap 1 t/m 5 om tot 2 identieke panelen te komen.



MONTAGE STAPPENPLAN

Montage stap 7

- 1x Balk 67x44mm van 59,5 cm
- 4x Schroef 120mm

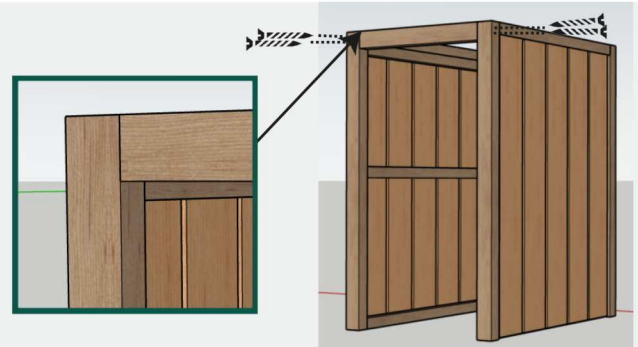

Montage stap 8

- 1x Balk 67x44mm van 59,5 cm
- 4x Schroef 120mm

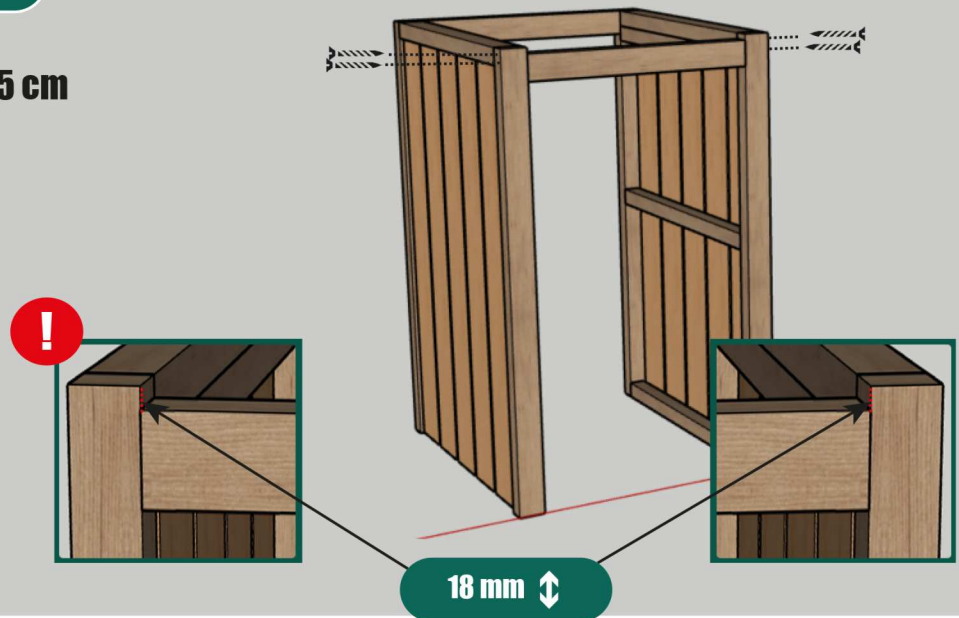

Montage stap 9

- 4x Stoeelhoek
- 8x Slagplug 40mm
- 8x Schroef 30mm

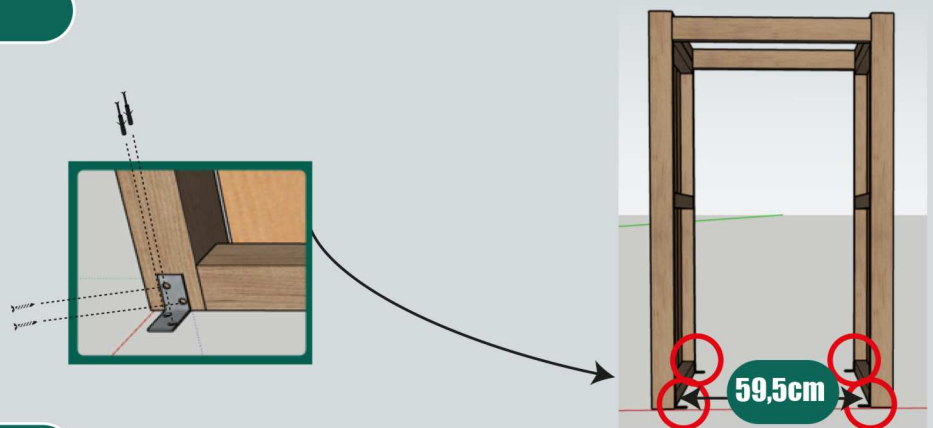

Montage stap 10

- 4x Plank 135x16mm van 83cm
- 2x Plank 135x16mm van 58,5cm
- 32x Schroef 30mm

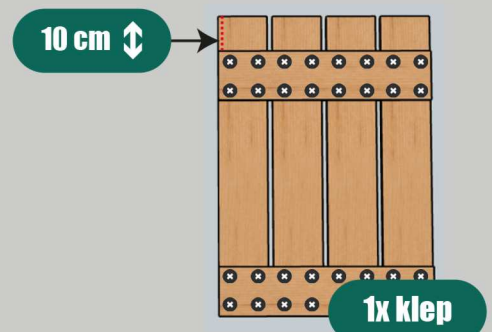

MONTAGE STAPPENPLAN

Montage stap 11

- 4x Plank 135x16mm van 107,5cm
- 2x Plank 135x16mm van 58,5cm
- 1x Plank 135x16mm van 80cm (schuin)
- 46x Schroef 30mm

10 cm 

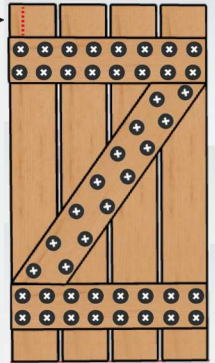

1x deur

Montage stap 12

- 1x Klep
- 2x Scharnier geheng kort
- 12x Schroef 30mm

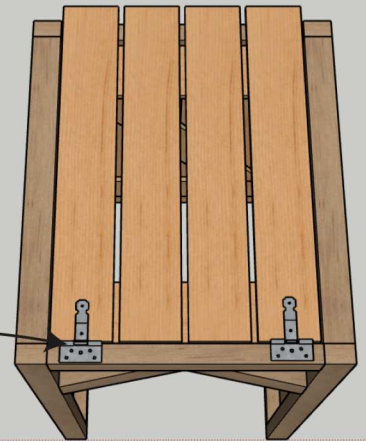
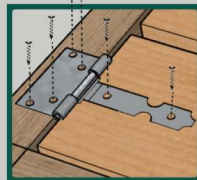

Montage stap 13

- 1x Deur
- 2x Scharnier geheng lang
- 1x Slot
- 18x Schroef 30mm

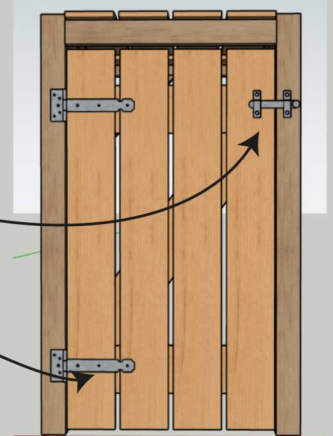
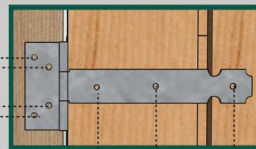
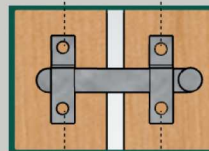

Montage stap 14

- 2x Balk 44x44mm (schuin gezaagd)
- 4x Schroef 80 mm

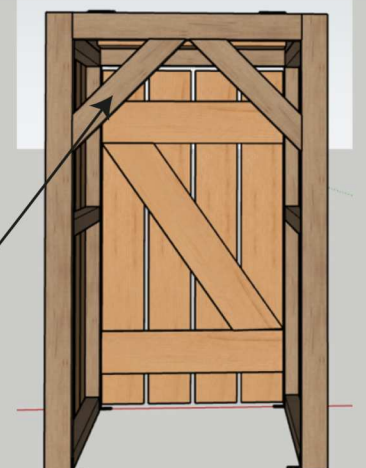

MONTAGE STAPPENPLAN

Montage stap 15

- 1x Ketting
- 1x Schroef 30mm

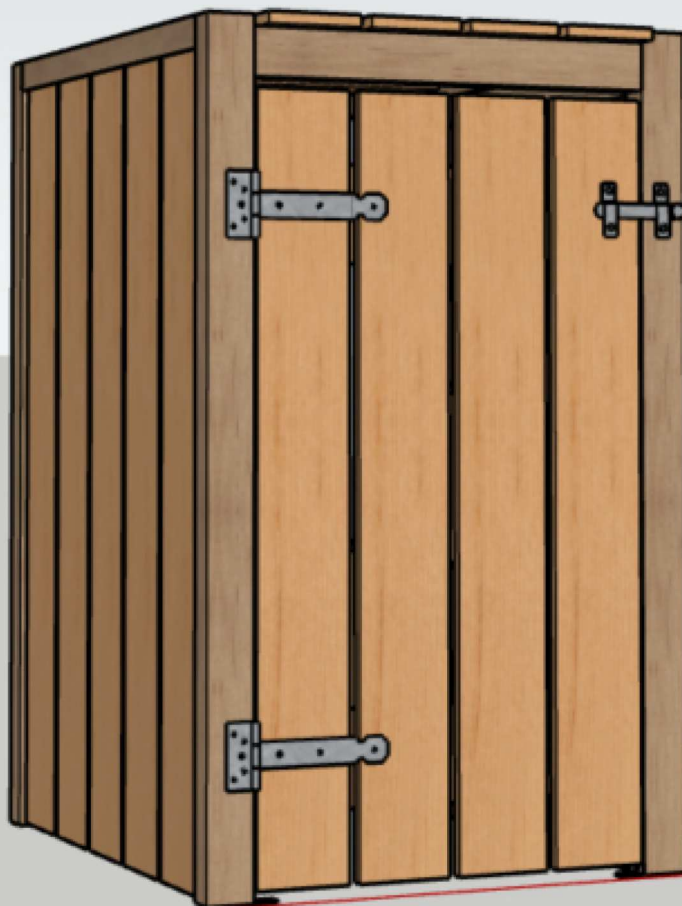
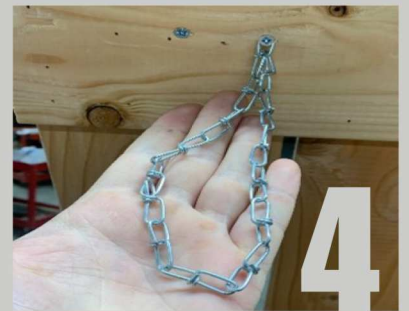

ACHTERWAND MONTAGE STAPPENPLAN

Plank 135 x 16 mm

118 CM



4x

Balk 44 x 44 mm

59,5 CM

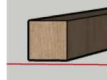

1x

Schroeven & pluggen

16x



Schroef 30 mm

4x



Schroef 100 mm

Montage stap 1

- 1x Balk 44x44mm van 59,5 cm
- 4x Schroef 100 mm



Montage stap 2

- 1x Plank 135x16mm van 118 cm
- 4x Schroef 30mm



Montage stap 3

- 3x Plank 135x16mm van 118 cm
- 12x Schroef 30mm



Verdeel de planken over de volledige breedte

